



Special Projects

OEM products developed in cooperation with customers



In House design and manufacturing. Brodit's manufacturing capacity makes it possible for us to manage requests for a single custom made product to high volume commercial orders.

One of Brodit's strengths is the short total production turn around time for a new product. Our unique knowledge and more than 35 years of experience is a great benefit to our customers.

At Brodit, the customer's wishes always come first! We work closely with our customers in order to develop products that are best suited for the users' needs. The concept also inspires and results in new product solutions.

If you need a product that is not available please contact Brodit; perhaps we can develop such a product in cooperation with you! In house design and manufacturing enables us to develop the most functional products, produced at the highest quality level.

Benefits:

- Unique product solutions perfectly made for specific needs & larger projects
- High grade ABS/Acetal plastic & aluminum
- Hand made samples to large quantities in state-of-the-art machinery
- Problem solving & creativity results in user friendly solutions
- Subcontracting & contract manufacturing
- Made in Sweden

More information available at www.brodit.com





PEDESTAL MOUNTS

**SUPER STRONG MOUNTING SOLUTIONS
FOR INSTALLATION OF HEAVIER DEVICES**



PEDESTAL MOUNTS

4	HEAVY DUTY PEDESTAL MOUNTS WITH WINGNUTS
5	HEAVY DUTY PEDESTAL MOUNTS
6	HEAVY DUTY PEDESTAL MOUNTS WITH TOP
7	PEDESTAL MOUNTS WITH SWIVELING TOP
7	ADJUSTABLE TABLET HOLDERS
8	PEDESTAL MOUNTS FOR CABLE ENTRY
9	STANDARD DUTY PEDESTAL MOUNTS
10	EXTRA FIRM PIPE MOUNTS
10	FIRM PIPE MOUNTS
11	STANDARD PIPE MOUNT
12	HEAVY DUTY FORKLIFT CLAMP MOUNTS
13	STANDARD DUTY FORKLIFT CLAMP MOUNTS
14	U-MOUNTS
15	HEAVY DUTY SUCTION CUP MOUNTS
16	MULTIMOVECLIP
17	TABLETOP FOOT
17	FLOOR STAND
18	HEAVY DUTY EXTENSION PARTS WITH SMALL TEETH
19	HEAVY DUTY EXTENSION PARTS WITH LARGE TEETH
20	MOUNTING BASE PLATES & TOPS
21	VIBRATION DAMPERS
21	WINGNUTS & SCREWS
21	VESA MOUNTING PLATES
22	EXTENSION PARTS & PLATES FOR CABLE ENTRY
23	TOPS & BASE/FOOT FOR CABLE ENTRY



PRODUCT IS COMPATIBLE WITH SQUARE BASE/TOP



PRODUCT IS COMPATIBLE WITH ROUND BASE/TOP



PRODUCT IS COMPATIBLE WITH CABLE ENTRY



PRODUCT IS COMPATIBLE WITH MOUNTS WITH SMALL TEETH



PRODUCT IS COMPATIBLE WITH MOUNTS WITH LARGE TEETH



PRODUCT HAS A SWIVELING FEATURE



PRODUCT IS EQUIPPED WITH WINGNUT



PEDESTAL MOUNTS

**SUPER STRONG MOUNTING SOLUTIONS
FOR INSTALLATION OF HEAVIER DEVICES**



- A modular system for a stable and strong installation of heavier devices
- Provides improved working environment with device within easy reach
- For use in any vehicle, flat surface, round pole or pipe, square rod
- Durable products with low weight, that withstand a lot of weight
- Contact Brodit for customized solutions on special projects
- Predrilled holes for easy attachment of a device holder
- Complete sets, or mix and match your own solution
- Heavy duty and standard duty range
- For professional everyday use
- Discreet design, color: black
- Solid and hollow range
- Made of aluminum
- Made in Sweden





HEAVY DUTY PEDESTAL MOUNTS WITH WINGNUTS

- A versatile Heavy Duty Pedestal Mount with wingnuts which allow for easy adjustment
- The joints are super strong, thanks to the small interlocking teeth
- The small interlocking teeth can be angled in 0-180° (16 positions in steps of 11,25°)
- Rod diameter 30 mm, solid rod
- Made of aluminum
- Square top: 50x50 mm, dual AMPS holes
- Round base/top: diameter 64 mm, multiple AMPS holes, radial adjustment



**SUPER STRONG
& WITH WINGNUTS
FOR EASY ADJUSTMENT!**



HEAVY DUTY PEDESTAL MOUNT WITH WINGNUTS ROUND BASE & SQUARE TOP

<i>Item no.</i>	<i>Product</i>	<i>Total height</i>
215836	Pedestal Mount 2" Round base, square top	62 mm
215837	Pedestal Mount 4" Round base, square top	114 mm
215838	Pedestal Mount 6" Round base, square top	164 mm
215937	Pedestal Mount 8" Round base, square top	214 mm



HEAVY DUTY PEDESTAL MOUNT WITH WINGNUTS ROUND BASE & TOP

<i>Item no.</i>	<i>Product</i>	<i>Total height</i>
215839	Pedestal Mount 2" Round base, round top	62 mm
215840	Pedestal Mount 4" Round base, round top	114 mm
215863	Pedestal Mount 6" Round base, round top	164 mm
215864	Pedestal Mount 8" Round base, round top	214 mm
215865	Pedestal Mount 10" Round base, round top	264 mm





HEAVY DUTY PEDESTAL MOUNTS

- Set the Heavy Duty Pedestal Mount into desired angles
- The joints are super strong, thanks to the large interlocking teeth
- The large interlocking teeth can be angled in 0-195° (8 positions in steps of 24°)
- Rod diameter 30 mm, solid rod
- Made of aluminum
- Square base/top: 50x50 mm, dual AMPS holes
- Round base/top: diameter 64 mm, multiple AMPS holes, radial adjustment



SUPER STRONG!



HEAVY DUTY PEDESTAL MOUNT WITH SQUARE BASE & TOP

<i>Item no.</i>	<i>Product</i>	<i>Total height</i>
215532	Pedestal Mount 2"	62 mm
215525	Pedestal Mount 4"	114 mm
215526	Pedestal Mount 6"	164 mm
215533	Pedestal Mount 8"	214 mm
215550	Pedestal Mount 10"	264 mm



HEAVY DUTY PEDESTAL MOUNT WITH ROUND BASE & TOP

<i>Item no.</i>	<i>Product</i>	<i>Total height</i>
215786	Pedestal Mount 2"	62 mm
215787	Pedestal Mount 4"	114 mm
215788	Pedestal Mount 6"	164 mm
215789	Pedestal Mount 8"	214 mm
215790	Pedestal Mount 10"	264 mm





HEAVY DUTY PEDESTAL MOUNTS WITH TOP



SWIVELING HEAVY DUTY PEDESTAL MOUNT

- Top part of the mount swivels 300°
- For installation of two devices back to back
- Mounting surfaces are angled 10° and 20°
- With MultiMoveClip, fits for all Brodit holders with tilt swivel
- Round base mounting plate, diameter 100 mm, thickness 9 mm, 6 holes
- Rod diameter 30 mm, solid rod, made of aluminum

<i>Item no.</i>	<i>Product</i>	<i>Total height</i>
215523	Swiveling Pedestal Mount 6"	262 mm



HEAVY DUTY PEDESTAL MOUNT 4" WITH MULTIMOVECLIP

- With MultiMoveClip, fits for all Brodit holders with tilt swivel
- Round base mounting plate, diameter 100 mm, thickness 9 mm, 6 holes
- Rod diameter 30 mm, solid rod, made of aluminum

<i>Item no.</i>	<i>Product</i>	<i>Total height</i>
215518	Pedestal Mount with MultiMoveClip"	138 mm



HEAVY DUTY PEDESTAL MOUNT 4" WITH BASE PLATE

- Square mounting plate, 50x50 mm, dual AMPS holes
- Round base mounting plate, diameter 100 mm, thickness 9 mm, 6 holes
- Rod diameter 30 mm, solid rod, made of aluminum

<i>Item no.</i>	<i>Product</i>	<i>Total height</i>
215563	Pedestal Mount 4"	124 mm





ca 345°

SWIVELS!

PEDESTAL MOUNTS WITH SWIVELING TOP

- A light weight, smaller size Pedestal Mount perfect for use in cramped places
- Slim design top, rod diameter 30 mm, solid rod, made of aluminum
- Height 117 mm + top
- Swiveling top turns approximately 345°, made of Acetal plastic
- Dual AMPS holes

LIGHT WEIGHT & SMALLER SIZE!

Item no.	Product	Top angle
215815	Swiveling Pedestal Mount	15° angled top
215816	Swiveling Pedestal Mount	30° angled top
215817	Swiveling Pedestal Mount	45° angled top
215818	Swiveling Pedestal Mount	60° angled top
215819	Swiveling Pedestal Mount	75° angled top
215820	Swiveling Pedestal Mount	90° angled top



ADJUSTABLE TABLET HOLDERS

- Adjustable tablet holder for use with devices with or without a skin/case
- Easy to place/remove device in holder
- The holder is equipped with a tilt swivel, tilts 17° and swivels 360°
- Add a MultiMoveClip for easy attachment/removal on a Pedestal Mount (only included with the sets listed below, not included with the adjustable tablet holder)
- Measure the height and thickness of your device with/without skin/case and compare with list below

ADJUSTABLE TABLET HOLDERS

Item no.	Device height	Device thickness
511848	120-150 mm	max 25 mm
511849	140-195 mm	max 25 mm
511850	180-230 mm	max 25 mm
511971	120-150 mm	max 30 mm
511972	140-195 mm	max 30 mm
511973	180-230 mm	max 30 mm

SET: ADJUSTABLE TABLET HOLDER & PEDESTAL MOUNT WITH SWIVELING TOP 45°

Item no.	Device height	Device thickness
215855	120-150 mm	max 25 mm
215856	140-195 mm	max 25 mm
215857	180-230 mm	max 25 mm



HOLDER FOR TABLETS WITH/WITHOUT CASE/SKIN





PEDESTAL MOUNTS FOR CABLE ENTRY

- Hollow Pedestal Mounts for cable entry
- For use on store counter tops, events , fairs etc.
- Available with a fixed top and a swiveling top
- Swiveling top turns approximately 345°, made of Acteal plastic
- Rod diameter 35 mm, hole inside diameter 25 mm, made of aluminum
- With MultiMoveClip, fits for all Brodit holders with tilt swivel

**HOLLOW RANGE
FOR CABLE ENTRY!**



PEDESTAL MOUNT FOR CABLE ENTRY, WITH SWIVELING TOP

Top angle	15°	30°	45°	60°	75°	90°
Height 4,5" + top	215629	215630	215631	215632	215633	215634
Height 6,5" + top	215635	215636	215637	215638	215639	215640
Height 8,5" + top	215641	215642	215643	215644	215645	215646



PEDESTAL MOUNT FOR CABLE ENTRY, WITH FIXED TOP

Top angle	15°	30°	45°	60°	75°	90°
Height 4" + top	215611	215612	215613	215614	215615	215616
Height 6" + top	215617	215618	215619	215620	215621	215622
Height 8" + top	215623	215624	215625	215626	215627	215628





STANDARD DUTY PEDESTAL MOUNTS

- With ball head, size 20 mm. Tilts 210°, swivels 360°
- Rod diameter 23 mm, loading weight 1-3 kg
- Rod made of aluminum, wingnut made of plastic
- Mounting plate 42x50 mm, AMPS holes
- Compatible with all Brodit holders with tilt swivel



STANDARD DUTY PEDESTAL MOUNT

<i>Item no.</i>	<i>Product</i>	<i>Total height</i>
202016	Pedestal Mount 5"	132 mm
202010	Pedestal Mount 6,5"	165 mm
202020	Pedestal Mount 10"	251 mm
202017	Pedestal Mount 6" with suction cup	160 mm
202011	Pedestal Mount 7,5" with suction cup	190 mm
202012	Pedestal Mount 11" with suction cup	280 mm
202015	Pedestal Mount 10" with small clamp mount Opens max 40 mm or Ø30 mm.	345 mm
202014	Pedestal Mount 10" with heavy duty clamp mount Opens 5-65 mm	340 mm
202019	Pedestal Mount 6,5" with cup holder mount	234 mm
202018	Pedestal Mount 10,5" with cup holder mount	267 mm



Item no.
202019

Item no.
202018



Item no.
202016

Item no.
202010

Item no.
202020

Item no.
202017

Item no.
202011

Item no.
202012

Item no.
202015

Item no.
202014



EXTRA FIRM PIPE MOUNTS

- A pipe mount for round bars. Perfect for installations in heavy duty vehicles or where road conditions are rough
- For use on motorcycles, boats, carts, stands, wheelchairs, airplanes etc
- Provides a very sturdy mounting platform for tablets, rugged PDAs, smartphones, monitors, printers etc
- Mounting plate 69x75 mm with multiple AMPS holes (M4x12 screws)



<i>Item no.</i>	<i>Product</i>	<i>Diameter</i>
215935	Pipe mount	Fits diameter 25 mm (40 mm if insert removed)
215858	Pipe mount	Fits diameter 30 mm (40 mm if insert removed)
215859	Pipe mount	Fits diameter 35 mm (40 mm if insert removed)
215860	Pipe mount	Fits diameter 40 mm



**EXTRA STRONG
PIPE MOUNT!**

FIRM PIPE MOUNTS

- The BarGrip is a pipe mount for round pipes/bars
- Easy to install, a very tight fit
- Available with fixed mounting plate or an adjustable tilting arm
- Mounting plate 50x42 mm
- Made of plastic



BARGRIP

- Fits for round pipes/bars 22-31 mm

<i>Item no.</i>	<i>Product</i>
215792	Swiveling mounting plate on arm, tilts 210°, rotates 360°
215793	Fixed mounting plate, AMPS holes
215794	Fixed mounting plate, 4 holes for nut + bolt

BARGRIP XL

- Fits for round pipes/bars 31-50 mm

<i>Item no.</i>	<i>Product</i>
215944	Swiveling mounting plate on arm, tilts 210°, rotates 360°
215945	Fixed mounting plate, AMPS holes
215946	Fixed mounting plate, 4 holes for nut + bolt





STANDARD PIPE MOUNTS

- For installation of devices on pipes and rods/bars
- For use on most types of vehicles, trucks, motorcycles, boats, carts, stands, wheelchairs, airplanes etc
- Item no. 215938+215966+215969 are made of aluminum
- Item no 215664-215667 are made of ABS/Acetal plastic

**STANDARD
PIPE MOUNT!**



Item no.
215664

Item no.
215938

Item no.
215969

Item no.
215966

Item no.
215665

Item no.
215666

Item no.
215667

<i>Item no.</i>	<i>Product</i>	<i>Fits pipe diameter</i>	<i>Holes</i>
215664	Pipe mount, Mounting plate 50x42 mm	19-30 mm	AMPS holes
215938	Pipe mount, Mounting plate 55x42 mm	19-30 mm	Dual AMPS holes
215969	Pipe mount with wingnuts, Mounting plate 50x40 mm	29-40 mm	AMPS holes
215966	Pipe mount with MultiMoveClip, With locking knobs, easy to install/remove	20 mm	
215665	Pipe mount, Mounting plate 160x50 mm	19-30 mm	6 holes AMPS
215666	Pipe mount, Mounting plate angled 45°	19-30 mm	6 holes AMPS
215667	Pipe mount, Mounting plate angled 90°	19-30 mm	6 holes AMPS





HEAVY DUTY FORKLIFT CLAMP MOUNTS

- For installation onto square objects, such as the roll bar of a forklift, rods, poles, tubes, plates, pipes.
- Made of aluminum
- Fits square objects with thickness 5-130 mm



HEAVY DUTY CLAMP MOUNT, AMPS

- Multiple AMPS holes
- Width between rods 87 mm

Item no.	Product
215677	Forklift Mount, multiple AMPS holes



HEAVY DUTY CLAMP MOUNT WITH PEDESTAL MOUNT FOOT

- Large interlocking teeth Heavy Duty Pedestal Mount foot
- Width between rods 36 mm

Item no.	Product
215784	Forklift Mount, integrated top/base



**MOUNT ON
SQUARE OBJECTS!**





STANDARD DUTY FORKLIFT CLAMP MOUNTS

- For installation onto square objects, e.g. rollbar of a forklift, rods, poles, tubes, plates, pipes.
- Fits square objects with thickness 5-130 mm
- With a Standard Duty Pedestal Mount arm with wingnuts
- Mounting plate 50x42 mm
- Made of aluminum
- AMPS holes



Item no. 215978



Item no. 215979



Item no. 215980



Item no. 215981

FORKLIFT CLAMP MOUNT WITH STANDARD DUTY PEDESTAL MOUNT ARM

Item no.	Product
215978	Length 140 mm, width between rods 72 mm
215979	Length 172 mm, width between rods 72 mm
215980	Length 140 mm, width between rods 97 mm
215981	Length 172 mm, width between rods 97 mm





U-MOUNTS

- For installation onto square objects, such as the rollbar of a fork lift or a square pillar in a ware house
- Fits rods/bars 35-40 mm or 45-50 mm
- Made of aluminum
- Dual AMPS holes

**MOUNT ON
SQUARE OBJECTS!**



<i>Item no.</i>	<i>Product</i>
215709	U-Mount. Fits bars 45-50 mm wide
215710	U-Mount. Fits bars 35-40 mm wide





HEAVY DUTY SUCTION CUP MOUNTS

- Extra strong, heavy duty suction cup mounts
- Provides a firm installation on flat surfaces such as glass or metal
- Dual AMPS holes

**EXTRA STRONG
SUCTION CUP!**



Item no. 215712



Item no. 215675



Item no. 215854

<i>Item no.</i>	<i>Product</i>
215712	Single Suction Cup Mount
215671	Dual Suction Cup Mount
215675	Triple Suction Cup Mount
215854	Dual Suction Cup Mount with Pedestal Mount 8"
215676	Wingnut + distance plate
215679	Distance plate, 5 pcs



Item no. 215676



Item no. 215679





MULTIMOVECLIP

- An adapter system for easy attachment and removal of a holder onto a mount
- Allows you to easily switch holders without changing the mount
- Move the holder between vehicle-warehouse-office
- Made of Acetal/ABS plastic
- Compatible with all Brodit holders with tilt swivel
- AMPS holes

**INSERT & REMOVAL
OF HOLDER IN SECONDS!**



Item no. 215699



Item no. 215538



Item no. 215668



Item no. 215718



Item no. 215822

<i>Item no.</i>	<i>Product</i>
215699	MultiMoveClip, high strength easy open
215538	MultiMoveClip, high strength
215668	MultiMoveClip
215718	MultiMoveClip, high strength easy open high
215822	MultiMoveClip, high strength easy open high, with lock + 2 keys
215591	Screw set. 4 screws + 4 nuts + 1 torx key. Color: Black (for installing a MultiMoveClip onto a Pedestal Mount)
216591	Screw set. 4 screws + 4 nuts + 1 torx key. Color: Silver (for installing a MultiMoveClip onto a Pedestal Mount)
215527	Adapter plate, for use of holder without tilt swivel on MultiMoveClip



Item no.
215527



Item no.
215591





STABLE STANDS FOR CABLE ENTRY

- Hollow range for cable entry, center hole diameter 15 mm
- Milled cable groove in the bottom

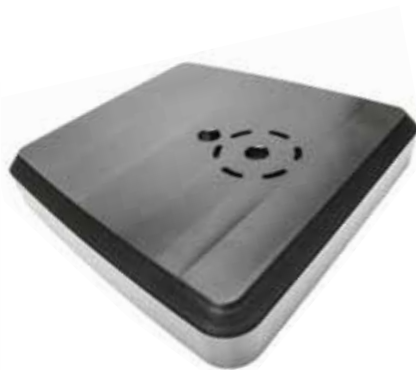

Item no. 215961

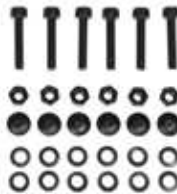

TABLETOP FOOT FOR CABLE ENTRY

- A stable mounting platform for all Pedestal Mounts (Pedestal Mount NOT included)
- For any device in shops, at exhibitions, events, reception desks, kiosks etc
- 230x230x40 mm (LxWxH), 2571 g
- Multiple AMPS holes, radial adjustment
- Made of Acetal plastic

TABLETOP FOOT FOR PEDESTAL MOUNT SOLID & HOLLOW RANGE

Item no.	Product	Holes
215961	Stable tabletop base for cable entry	Multiple AMPS holes, radial adjustment



FLOOR STAND FOR CABLE ENTRY

- A stable mounting platform for any device in shops, at exhibitions, at events, receptions, etc.
- 30x30x113 cm (LxWxH), 13,7 kg
- Made of aluminum, top made of Acetal plastic
- Dual AMPS holes + 4 holes
- Angled top 45°

FLOOR STAND WITH ANGLED TOP 45° FOR CABLE ENTRY

Item no.	Product	Holes
215678	Stable floor stand for cable entry	Dual AMPS holes + 4 holes



Item no. 215678

HEAVY DUTY EXTENSION PARTS WITH SMALL TEETH



- Create your own unique solution by combining various Heavy Duty Pedestal Mount parts
- The joints are super strong, thanks to the small interlocking teeth, can be angled in 0-180° (16 positions in steps of 11,25°)
- With wingnuts which allow for easy adjustment (NOT included in base/top)
- Rod diameter 30 mm, solid rod
- Made of aluminum
- NOTE: Each part is marked 1 or 2. In order to make a straight design (angle 0°), you need to match a "part 1" with a "part 2". If you mount "part 1" onto "part 1", or "part 2" onto "part 2", it will not be possible to create a straight (angle 0°) design, but the parts will still be compatible. (Only applies for the heavy duty Pedestal Mounts with small interlocking teeth.)

WITH SMALL TEETH



Item no. 215846



Item no. 215767

<i>Item no.</i>	<i>Product</i>	<i>Total length</i>	<i>Inner length</i>	<i>CC-dimension</i>
215766	Extension rod 2"	82 mm	14 mm	52 mm
215846	Extension rod 4"	132 mm	64 mm	102 mm
215762	Extension rod 6"	182 mm	114 mm	152 mm
215847	Extension rod 8"	232 mm	164 mm	202 mm
215767	Extension rod 2", 90° angle	82 mm	14 mm	52 mm



Item no. 215850



Item no. 215849

<i>Item no.</i>	<i>Product</i>	<i>Total length</i>	<i>CC-dimension</i>
215850	Base/top, square mounting plate 50x50 mm ("part 2") Dual AMPS holes	46 mm	31 mm



<i>Item no.</i>	<i>Product</i>	<i>Total length</i>	<i>CC-dimension</i>
215849	Base/top, round mounting plate 64 mm diameter ("part 1") Multiple AMPS holes, radial adjustment	46 mm	31 mm
215768	Base/top, round mounting plate 64 mm diameter ("part 2") Multiple AMPS holes, radial adjustment	46 mm	31 mm

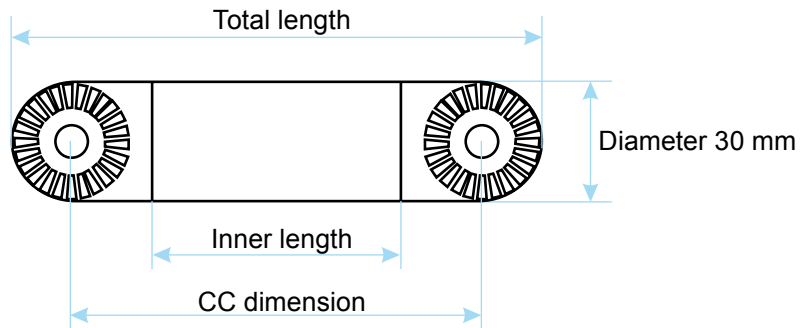

HEAVY DUTY EXTENSION PARTS WITH LARGE TEETH



- Create your own unique solution by combining various Heavy Duty Pedestal Mount parts
- The joints are super strong, thanks to the large interlocking teeth, can be angled in 0-195° (8 positions in steps of 24°)
- Rod diameter 30 mm, solid rod
- Made of aluminum



Item no. 215514

WITH LARGE TEETH



Item no. 215724



Item no. 215674

<i>Item no.</i>	<i>Product</i>	<i>Total length</i>	<i>Inner length</i>	<i>CC-dimension</i>
215515	Extension rod 2"	82 mm	14 mm	52 mm
215514	Extension rod 4"	132 mm	64 mm	102 mm
215534	Extension rod 6"	182 mm	114 mm	152 mm
215549	Extension rod 8"	232 mm	164 mm	202 mm
215724	Extension rod 2", 90° angle	82 mm	14 mm	52 mm
215674	Extension rod 4", rotatable	132 mm	64 mm	102 mm



Item no. 215516



Item no. 215785

<i>Item no.</i>	<i>Product</i>	<i>Total length</i>	<i>CC-to surface</i>
215516	Base/top, square mounting plate 50x50 mm Dual AMPS holes	46 mm	31 mm



<i>Item no.</i>	<i>Product</i>	<i>Total length</i>	<i>CC-to surface</i>
215785	Base/top, round mounting plate 46 mm diameter Multiple AMPS holes, radial adjustment	46 mm	31 mm

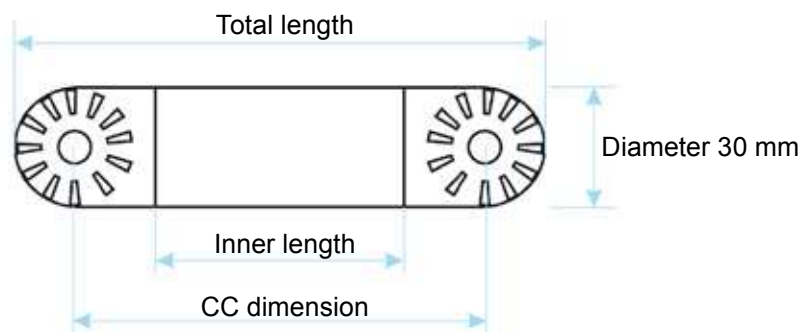

MOUNTING BASE PLATES & TOPS

- Create your own unique solution by combining mounting plates and tops with various Pedestal Mount parts



Item no. 215522



Item no. 215597



ROUND MOUNTING/BASE PLATE

- Round mounting/base plates for added stability
- Spreads the strain on the mounting surface thanks to hole pattern over a larger area
- Made of ABS plastic
- Thickness 9 mm

Item no.	Product	Diameter	Holes
215522	Round mounting plate	100 mm	AMPS holes + 6 holes
215807	Round mounting plate	200 mm	AMPS holes



Item no.	Product	Diameter	Holes
215597	Round mounting plate	100 mm	2x6 holes
215598	Round mounting plate	150 mm	2x6 holes
215599	Round mounting plate	200 mm	2x6 holes



SWIVELS!



Item no. 215521

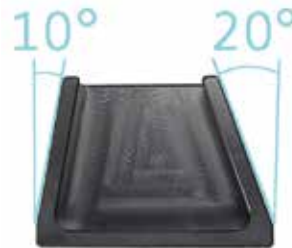

Item no. 215524



SWIVELING TOP PLATE

- For installation of equipment that needs to be turned for use from different directions
- Made of aluminum
- Swivels 300°. Diameter 64 mm. Thickness 22 mm

Item no.	Product	Holes
215521	Swiveling top plate, adjustable in fixed steps	AMPS-holes + 4 holes
215905	Swiveling top plate, stepless adjustment	AMPS-holes + 4 holes



ANGLED TOP PART

- For installation of two devices back to back, for example a payment terminal and a printer
- Mounting surfaces are angled 10° and 20°
- Made of Acetal plastic
- Dimensions 64x64x46 mm (L+W+H)

Item no.	Product	Holes
215524	Angled top part 10° and 20°	3xAMPS holes + 1 large hole



VIBRATION DAMPERS

- Reduces vibrations and bumps, for use in a rough environment
- Mount the vibration dampers between the holder and the Pedestal Mount
- Damper builds 17 mm, damper plate builds 22 mm
- AMPS holes



Item no. 215881



Item no. 215997



REDUCES VIBRATIONS & BUMPS!

Item no.	Product	Max weight
215881	Vibration damper, hard (2 pcs)	For installations weighing up to 1500g
215882	Vibration damper, soft (2 pcs)	For installations weighing up to 300g
215998	Vibration damper plate 68x68 mm, hard	For installations weighing up to 1500g
215997	Vibration damper plate 68x68 mm, soft	For installations weighing up to 300g



WINGNUTS & SCREWS

- For use on all Heavy Duty Pedestal Mounts (NOT for Standard Duty Pedestal Mounts)



Item no. 215670



Item no. 215535

Item no.	Product
215670	Wing nuts. Replaces standard nuts on Heavy Duty Pedestal Mounts (2 pcs)
215535	Screws. 2 screws + 2 nuts + 1 Allen key. For Heavy Duty Pedestal Mounts. Color: Black
216535	Screws. 2 screws + 2 nuts + 1 Allen key. For Heavy Duty Pedestal Mounts. Color: Silver



VESA MOUNTING PLATES

- For use on all Heavy Duty Pedestal Mounts
- Made of aluminum



Item no. 215756



Item no. 215748



Item no. 215753

Item no.	Product	Holes
215791	Single Vesa: 75 mm, rounded plate	Vesa + AMPS holes
215756	Dual Vesa: 75 mm and 100 mm, rounded plate	Dual Vesa + AMPS holes
215753	5 x Vesa: 75 mm, square plate	5 x Vesa + AMPS holes
215748	Single Vesa 75 mm, square plate	Vesa + AMPS holes



EXTENSION PARTS & PLATES FOR CABLE ENTRY MOUNTS

- Create your own unique solution for cable entry by combining various extension parts
- Hollow Pedestal Mounts for cable entry
- Made of aluminum
- Rod diameter 35 mm, hole inside diameter 25 mm
- For use on all heavy duty Pedestal Mounts
- Made of plastic

**HOLLOW RANGE
FOR CABLE ENTRY**



EXTENSION PARTS FOR CABLE ENTRY, WITH SWIVELING TOP

- Hollow Pedestal Mount extension part with swiveling top for cable entry
- 5 sets of AMPS-holes on top part
- Round mounting plate with 6 holes

<i>Item no.</i>	<i>Product</i>	<i>Total height</i>
215572	Swiveling Pedestal Mount for cable entry 4,5"	115 mm
215573	Swiveling Pedestal Mount for cable entry 6,5"	165 mm
215574	Swiveling Pedestal Mount for cable entry 8,5"	215 mm



EXTENSION PARTS FOR CABLE ENTRY

- Hollow Pedestal Mount extension parts for cable entry
- 4 sets of AMPS-holes on top part
- Round mounting plate with 6 holes

<i>Item no.</i>	<i>Product</i>	<i>Total height</i>
215564	Pedestal Mount for cable entry 4"	100 mm
215565	Pedestal Mount for cable entry 6"	150 mm
215566	Pedestal Mount for cable entry 8"	200 mm



ROUND MOUNTING/BASE PLATES FOR CABLE ENTRY

- Hollow Pedestal Mount mounting/base plates for cable entry
- Round mounting plates for added stability
- Spreads the strain on the mounting surface thanks to larger hole area
- Milled cable groove in the bottom
- Made of ABS plastic
- Thickness 9 mm.

<i>Item no.</i>	<i>Product</i>	<i>Diameter</i>
215757	Mounting plate for cable entry	200 mm
215795	Mounting plate for cable entry	250 mm



TOPS & BASE/FOOT FOR CABLE ENTRY MOUNTS

- Create your own unique solution for cable entry by combining various extension parts with top parts
- Hollow Pedestal Mount tops for cable entry



SWIVELING TOPS FOR CABLE ENTRY PEDESTAL MOUNT

- Square mounting plate 50x50 mm
- Made of aluminum and Acetal plastic
- Tilts 180°

Item no.	Product	Holes
215717	Top Part with 180° turnaround. Locking with handle	Dual AMPS holes + 4 holes
215741	Top Part with 180° turnaround. Locking with handle	RAM Mount holes + 4 holes
215742	Top Part with 180° turnaround. Locking with Allen Key	Dual AMPS holes + 4 holes



**HOLLOW RANGE
FOR CABLE ENTRY**



ANGLED TOPS FOR CABLE ENTRY PEDESTAL MOUNT

- Made of Acetal plastic

Item no.	Product	Top angle	Total height	Holes
215568	Angled top for cable entry	Angle: 15°	26 mm	Dual AMPS holes + 4 holes
215569	Angled top for cable entry	Angle: 30°	44 mm	Dual AMPS holes + 4 holes
215570	Angled top for cable entry	Angle: 45°	50 mm	Dual AMPS holes + 4 holes
215571	Angled top for cable entry	Angle: 60°	50 mm	Dual AMPS holes + 4 holes
215595	Angled top for cable entry	Angle: 75°	50 mm	Dual AMPS holes + 4 holes
215596	Angled top for cable entry	Angle: 90°	50 mm	Dual AMPS holes + 4 holes



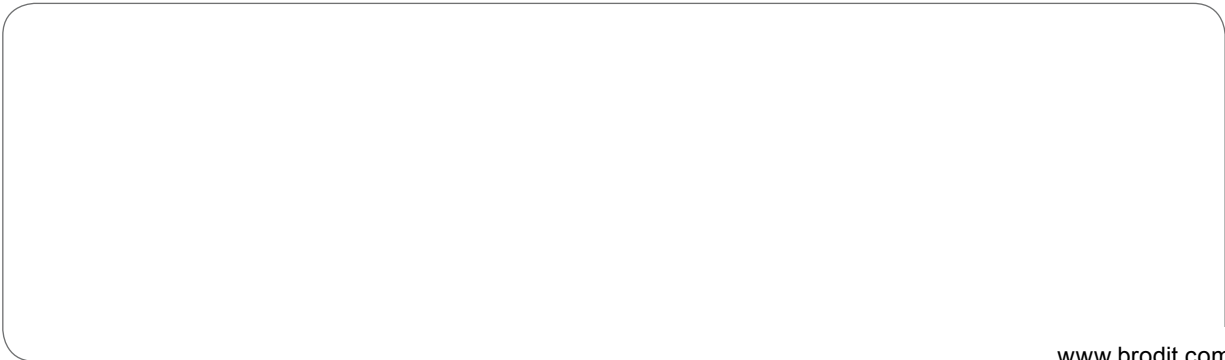
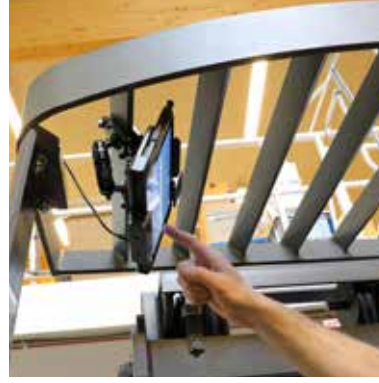

Keep things within reach

Taxi & Heavy Duty Mounts

Extra strength mounting platform

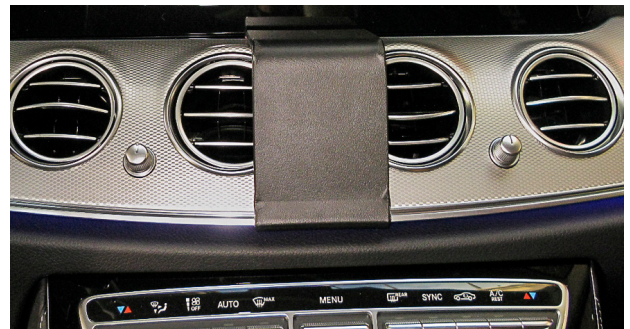

Brodit high strength mounting bracket is a mounting platform that you install in your car. It serves as a base for communication device holders. Keep your device attached to the dashboard in a secure and convenient way - always within easy sight and reach!

Brodit can offer heavy duty mounting brackets suitable for mounting taxi equipment or similar heavy devices. The brackets can hold taximeters, payment terminals, printers or larger navigation screens, only to mention a few.

Does not damage the interior: The interior of the vehicle will not be damaged as no drilling of holes is required, you do not need to dismantle the dashboard.

Newest items:

- Item 213525 - Volvo S90, V90 17-18
- Item 213500 - VW Passat Alltrack, 16-17
- Item 213496 - Skoda Octavia, 13-18
- Item 213510 - Skoda Fabia, 15-17
- Item 213511 - Skoda Rapid, 13-17
- Item 213509 - Ford Transit, 14-17
- Item 213514 - Toyota Auris, 16-17
- Item 213520 - Renault Master, 11-17

More information available at www.brodit.com



Keep things within reach

Pedestal Mounts

Super strong mounting of heavier devices

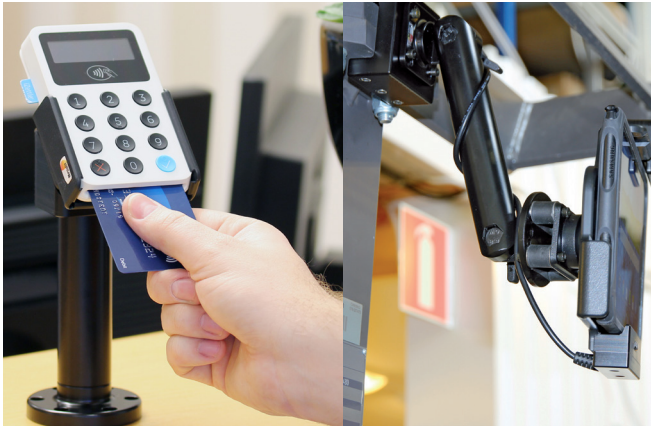

- A modular system for a stable and strong installation of heavier devices
- Provides improved working environment with device within easy reach
- For use in any vehicle, flat surface, round pole or pipe, square rod
- Durable products with low weight, that withstand a lot of weight
- Contact Brodit for customized solutions on special projects
- Predrilled holes for easy attachment of a device holder
- Complete sets, or mix and match your own solution
- For professional everyday use
- Discreet design, color: black
- Solid and hollow range
- Made of aluminum
- Made in Sweden

More information available at www.brodit.com



Keep things within reach



Rugged PDA Holders

Professional use



Brodit Rugged PDA Holders are customized holders and mounting platforms for professional installation of handheld devices. Strong mounting platforms for rough environments, heavier devices in professional everyday use. Rugged PDA holders are for: Taxi-vehicle, busses, Trucks, distribution vehicle and many more vehicle for everyday professional use. i.e devices for Rugged PDA: Tablets, bar code scanners, printers, payment terminals, and many more.

With your PDA in a holder from Brodit, mounted on your dashboard you will always have your device within easy sight and reach. Safe, smart and convenient. Holders are available as passive without charging, and active with built-in charging via cigarette lighter plug or fixed hard-wire installation.

All holders are equipped with a tilt swivel, allowing for the holder to be adjusted to avoid light reflection in the screen. The holder is easily attached onto a ProClip mounting platform designed specifically for your car. Also for some models; table stands are available in order to always ensure a freshly charged battery when leaving the offices.

Benefits:

- Within easy sight and reach in the car
- Active holders guarantee a freshly charged battery
- Tilt swivel allows adjustment
- Customized design for perfect fit

More information available at www.brodit.com





PRINTER HOLDERS

CUSTOMIZED HOLDERS & ADAPTERS FOR FUNCTIONALITY
& CONVENIENCE IN PROFESSIONAL EVERYDAY USE



BRODIT AB OFFERS AN **EASY** AND **SECURE** WAY TO MOUNT DEVICES IN ANY VEHICLE, ANY FLAT SURFACE, POLE OR PIPE . THE BRODIT **2-PART MOUNTING SOLUTION** CONSISTS OF **CUSTOMIZED DEVICE HOLDERS**, WHICH YOU ATTACH ONTO A **PROCLIP**, A **VEHICLE SPECIFIC MOUNTING PLATFORM**, OR A **PEDESTAL MOUNT**.







BRODIT PRODUCTS ARE VERY **ROBUST** AND **STRONG**, DESIGNED FOR WEAR AND TEAR IN EVERYDAY PROFESSIONAL USE. COMBINING **FUNCTIONALITY** AND **CONVENIENCE**, THE BRODIT **2-PART MOUNTING SOLUTION** CONTRIBUTES TO AN **IMPROVED WORKING ENVIRONMENT**.

PLEASE CONTACT BRODIT AB FOR **CUSTOMIZED SOLUTIONS** ON **SPECIAL PROJECTS**.

PRINTER HOLDERS & PEDESTAL MOUNTS

3	BIXOLON R200
4	INFORMS LK-P12
5	TOSHIBA B-FP3D
6	ZEBRA QLN 220, 320
7	ZEBRA QLN 420
8	ZEBRA ZD410
9	ZEBRA ZD420, 620
10	ZEBRA ZQ520
11	WOOSIM PORTI S, W 25
12	HEAVY DUTY PEDESTAL MOUNTS WITH WINGNUT
13	HEAVY DUTY PEDESTAL MOUNTS
14	STANDARD DUTY PEDESTAL MOUNTS
15	EXTRA FIRM PIPE MOUNTS & FIRM PIPE MOUNTS
16	STANDARD PIPE MOUNT
17	HEAVY DUTY FORKLIFT CLAMP MOUNTS
18	STANDARD DUTY FORKLIFT CLAMP MOUNTS
19	VIBRATION DAMPERS

SYMBOLS

	PRODUCT IS COMPATIBLE WITH SQUARE BASE/TOP
	PRODUCT IS COMPATIBLE WITH ROUND BASE/TOP
	PRODUCT IS COMPATIBLE WITH MOUNTS WITH SMALL TEETH
	PRODUCT IS COMPATIBLE WITH MOUNTS WITH LARGE TEETH
	PRODUCT HAS A SWIVELING FEATURE
	PRODUCT IS EQUIPPED WITH WINGNUT



BIXOLON R200

- Active holder with charging, with cig-plug cable 12/24V
- Extra robust design, very strong holder
- Easy insert/removal of the printer in the holder
- Dimensions: 91 x 138 x 42 mm (W x H x D mm)
- Weight: 214 g
- Cable length (+plug 9 cm): 185 cm
- AMPS holes
- Made of high grade Acetal plastic
- Made in Sweden



EXTRA ROBUST HOLDER!



Item no. 530870



BIXOLON R200

Item no.	Product
530870	Active holder with cig-plug



INFORMS LK-P12

- With quick release MultiMoveClip: easy to move your printer between locations
- With sliding power block: with charging of the printer (for use with the printer's original charger)
- AMPS holes
- Made of high grade ABS/Acetal plastic
- Made in Sweden



**MOUNT WITH/WITHOUT
CHARGING!**



Item no. 216002



Item no. 216003

INFORMS LK-P12

Item no.	Product
216002	Mount with MultiMoveClip
216003	Mount with sliding powerblock and MultiMoveClip

TOSHIBA

TOSHIBA B-FP3D

- With quick release MultiMoveClip: easy to move your printer between locations
- With vibration dampers: reduces vibrations and bumps in rugged environments
- AMPS holes
- Made of high grade ABS/Acetal plastic
- Made in Sweden



REDUCES VIBRATIONS!



Item no. 215962



TOSHIBA B-FP3D

<u>Item no.</u>	<u>Product</u>
215962	Mount with vibration dampers and MultiMoveClip



ZEBRA QLN 220, 320

- With quick release MultiMoveClip: easy to move your printer between locations
- With 2" Heavy Duty Pedestal Mount, made of Aluminum
- With sliding power block: with charging of the printer (for use with the printer's original charger)
- AMPS holes
- Made of high grade ABS/Acetal plastic
- Made in Sweden



Item no. 215806



Item no. 215842



Item no. 215803



Item no. 215843

ZEBRA QLN 220, 320

Item no.	Product
215806	Mount with MultiMoveClip
215842	Mount with MultiMoveClip, 2" Heavy Duty Pedestal Mount
215803	2" Heavy Duty Pedestal Mount with charging
215843	Mount with MultiMoveClip with charging, 2" Heavy Duty Pedestal Mount

MOUNT WITH/WITHOUT CHARGING!



ZEBRA QLN 420

- With quick release MultiMoveClip: easy to move your printer between locations
- AMPS holes
- Made of high grade ABS/Acetal plastic
- Made in Sweden

**EASY TO MOVE PRINTER
BETWEEN LOCATIONS!**



Item no. 216005



Item no. 216004



ZEBRA QLN 420

Item no. Product

216005 Mount

216004 Mount with MultiMoveClip



ZEBRA ZD410

- With quick release MultiMoveClip: easy to move your printer between locations
- AMPS holes
- Made of high grade black ABS or white Acetal plastic
- Made in Sweden



**EASY & SECURE WAY
TO MOUNT YOUR PRINTER!**



Item no. 216006



Item no. 216007



ZEBRA ZD410

Item no.	Product
216006	Passive holder with MultiMoveClip
216007	Passive holder with MultiMoveClip



ZEBRA ZD420 (NEW VERSION), 620

- With quick release MultiMoveClip: easy to move your printer between locations
- AMPS holes
- Made of high grade ABS/Acetal plastic
- Made in Sweden



Item no. 215993

**COMBINES FUNCTIONALITY
& CONVENIENCE!**

ZEBRA ZD420 (NEW VERSION, 620)

Item no. Product

215993 Mount with MultiMoveClip

ZEBRA ZD420 (OLD VERSION)

- With quick release MultiMoveClip: easy to move your printer between locations
- AMPS holes
- Made of high grade ABS/Acetal plastic
- Made in Sweden



Item no. 215947

ZEBRA ZD420 (OLD VERSION)

Item no. Product

215947 Mount with MultiMoveClip



ZEBRA ZQ520

- With quick release MultiMoveClip: easy to move your printer between locations
- AMPS holes
- Made of high grade ABS/Acetal plastic
- Made in Sweden



**EASY TO MOVE PRINTER
BETWEEN LOCATIONS!**



Item no. 215921



Item no. 216008



ZEBRA ZQ520

<i>Item no.</i>	<i>Product</i>
215921	Mount
216008	Mount with MultiMoveClip



WOOSIM PORTI W 25

- With quick release MultiMoveClip: easy to move your printer between locations
- With tilt swivel: tilts 17° and swivels 360°
- Mounting plate 42x50 mm
- AMPS holes
- Made of high grade ABS/Acetal plastic
- Made in Sweden



WITH TILT SWIVEL!



Item no. 213422

WOOSIM PORTI W 25

Item no. Product

213422 Passive holder with tilt swivel

WOOSIM PORTI S

- With quick release MultiMoveClip: easy to move your printer between locations
- With tilt swivel: tilts 17° and swivels 360°
- Mounting plate 42x50 mm
- AMPS holes
- Made of high grade ABS/Acetal plastic
- Made in Sweden

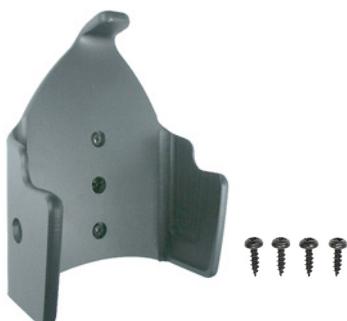

Item no. 213420

WOOSIM PORTI S

Item no. Product

213420 Passive holder with tilt swivel



HEAVY DUTY PEDESTAL MOUNTS WITH WINGNUTS

- A versatile Heavy Duty Pedestal Mount with wingnuts which allow for easy adjustment
- The joints are super strong, thanks to the small interlocking teeth
- The small interlocking teeth can be angled in 0-180° (16 positions in steps of 11,25°)
- Rod diameter 30 mm, solid rod
- Made of aluminum
- Square top: 50x50 mm, dual AMPS holes
- Round base/top: diameter 64 mm, multiple AMPS holes, radial adjustment



**SUPER STRONG
& WITH WINGNUTS
FOR EASY ADJUSTMENT!**



HEAVY DUTY PEDESTAL MOUNT WITH WINGNUTS ROUND BASE & SQUARE TOP

<i>Item no.</i>	<i>Product</i>	<i>Total height</i>
215836	Pedestal Mount 2" Round base, square top	62 mm
215837	Pedestal Mount 4" Round base, square top	114 mm
215838	Pedestal Mount 6" Round base, square top	164 mm
215937	Pedestal Mount 8" Round base, square top	214 mm



HEAVY DUTY PEDESTAL MOUNT WITH WINGNUTS ROUND BASE & TOP

<i>Item no.</i>	<i>Product</i>	<i>Total height</i>
215839	Pedestal Mount 2" Round base, round top	62 mm
215840	Pedestal Mount 4" Round base, round top	114 mm
215863	Pedestal Mount 6" Round base, round top	164 mm
215864	Pedestal Mount 8" Round base, round top	214 mm
215865	Pedestal Mount 10" Round base, round top	264 mm





HEAVY DUTY PEDESTAL MOUNTS

- Set the Heavy Duty Pedestal Mount into desired angles
- The joints are super strong, thanks to the large interlocking teeth
- The large interlocking teeth can be angled in 0-195° (8 positions in steps of 24°)
- Rod diameter 30 mm, solid rod
- Made of aluminum
- Square base/top: 50x50 mm, dual AMPS holes
- Round base/top: diameter 64 mm, multiple AMPS holes, radial adjustment



SUPER STRONG!



HEAVY DUTY PEDESTAL MOUNT WITH SQUARE BASE & TOP

<i>Item no.</i>	<i>Product</i>	<i>Total height</i>
215532	Pedestal Mount 2"	62 mm
215525	Pedestal Mount 4"	114 mm
215526	Pedestal Mount 6"	164 mm
215533	Pedestal Mount 8"	214 mm
215550	Pedestal Mount 10"	264 mm



HEAVY DUTY PEDESTAL MOUNT WITH ROUND BASE & TOP

<i>Item no.</i>	<i>Product</i>	<i>Total height</i>
215786	Pedestal Mount 2"	62 mm
215787	Pedestal Mount 4"	114 mm
215788	Pedestal Mount 6"	164 mm
215789	Pedestal Mount 8"	214 mm
215790	Pedestal Mount 10"	264 mm





STANDARD DUTY PEDESTAL MOUNTS

- With ball head, size 20 mm. Tilts 210°, swivels 360°
- Rod diameter 23 mm, loading weight 1-3 kg
- Rod made of aluminum, wingnut made of plastic
- Mounting plate 42x50 mm, AMPS holes
- Compatible with all Brodit holders with tilt swivel

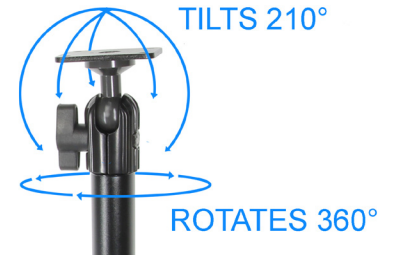

STANDARD DUTY PEDESTAL MOUNT

Item no.	Product	Total height
202016	Pedestal Mount 5"	132 mm
202010	Pedestal Mount 6,5"	165 mm
202020	Pedestal Mount 10"	251 mm
202017	Pedestal Mount 6" with suction cup	160 mm
202011	Pedestal Mount 7,5" with suction cup	190 mm
202012	Pedestal Mount 11" with suction cup	280 mm
202015	Pedestal Mount 10" with small clamp mount Opens max 40 mm or Ø30 mm.	345 mm
202014	Pedestal Mount 10" with heavy duty clamp mount Opens 5-65 mm	340 mm
202019	Pedestal Mount 6,5" with cup holder mount	234 mm
202018	Pedestal Mount 10,5" with cup holder mount	267 mm



Item no.
202019

Item no.
202018





EXTRA FIRM PIPE MOUNTS

- A pipe mount for round bars. Perfect for installations in heavy duty vehicles or where road conditions are rough
- For use on motorcycles, boats, carts, stands, wheelchairs, airplanes etc
- Provides a very sturdy mounting platform for tablets, rugged PDAs, smartphones, monitors, printers etc
- Mounting plate 69x75 mm with multiple AMPS holes (M4x12 screws)



<i>Item no.</i>	<i>Product</i>	<i>Diameter</i>
215935	Pipe mount	Fits diameter 25 mm (40 mm if insert removed)
215858	Pipe mount	Fits diameter 30 mm (40 mm if insert removed)
215859	Pipe mount	Fits diameter 35 mm (40 mm if insert removed)
215860	Pipe mount	Fits diameter 40 mm



**EXTRA STRONG
PIPE MOUNT!**

FIRM PIPE MOUNTS

- The BarGrip is a pipe mount for round pipes/bars
- Easy to install, a very tight fit
- Available with fixed mounting plate or an adjustable tilting arm
- Mounting plate 50x42 mm
- Made of plastic



BARGRIP

- Fits for round pipes/bars 22-31 mm

<i>Item no.</i>	<i>Product</i>
215792	Swiveling mounting plate on arm, tilts 210°, rotates 360°
215793	Fixed mounting plate, AMPS holes
215794	Fixed mounting plate, 4 holes for nut + bolt

BARGRIP XL

- Fits for round pipes/bars 31-50 mm

<i>Item no.</i>	<i>Product</i>
215944	Swiveling mounting plate on arm, tilts 210°, rotates 360°
215945	Fixed mounting plate, AMPS holes
215946	Fixed mounting plate, 4 holes for nut + bolt

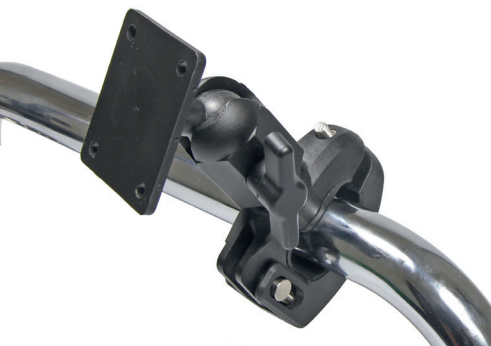



STANDARD PIPE MOUNTS

- For installation of devices on pipes and rods/bars
- For use on most types of vehicles, trucks, motorcycles, boats, carts, stands, wheelchairs, airplanes etc
- Item no. 215938+215966+215969 are made of aluminum
- Item no 215664-215667 are made of ABS/Acetal plastic

**STANDARD
PIPE MOUNT!**



Item no.	Product	Fits pipe diameter	Holes
215664	Pipe mount, Mounting plate 50x42 mm	19-30 mm	AMPS holes
215938	Pipe mount, Mounting plate 55x42 mm	19-30 mm	Dual AMPS holes
215969	Pipe mount with wingnuts, Mounting plate 50x40 mm	29-40 mm	AMPS holes
215966	Pipe mount with MultiMoveClip, With locking knobs, easy to install/remove	20 mm	
215665	Pipe mount, Mounting plate 160x50 mm	19-30 mm	6 holes AMPS
215666	Pipe mount, Mounting plate angled 45°	19-30 mm	6 holes AMPS
215667	Pipe mount, Mounting plate angled 90°	19-30 mm	6 holes AMPS





HEAVY DUTY FORKLIFT CLAMP MOUNTS

- For installation onto square objects, such as the roll bar of a forklift, rods, poles, tubes, plates, pipes.
- Made of aluminum
- Fits square objects with thickness 5-130 mm



HEAVY DUTY CLAMP MOUNT, AMPS

- Multiple AMPS holes
- Width between rods 87 mm

Item no.	Product
215677	Forklift Mount, multiple AMPS holes



HEAVY DUTY CLAMP MOUNT WITH PEDESTAL MOUNT FOOT

- Large interlocking teeth Heavy Duty Pedestal Mount foot
- Width between rods 36 mm

Item no.	Product
215784	Forklift Mount, integrated top/base



**MOUNT ON
SQUARE OBJECTS!**





STANDARD DUTY FORKLIFT CLAMP MOUNTS

- For installation onto square objects, e.g. rollbar of a forklift, rods, poles, tubes, plates, pipes.
- Fits square objects with thickness 5-130 mm
- With a Standard Duty Pedestal Mount arm with wingnuts
- Mounting plate 50x42 mm
- Made of aluminum
- AMPS holes



Item no. 215978

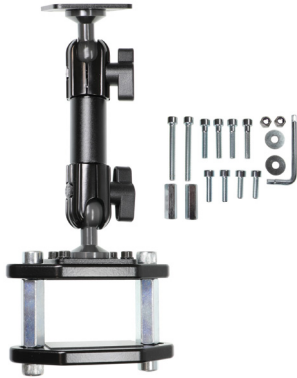

Item no. 215979



Item no. 215980

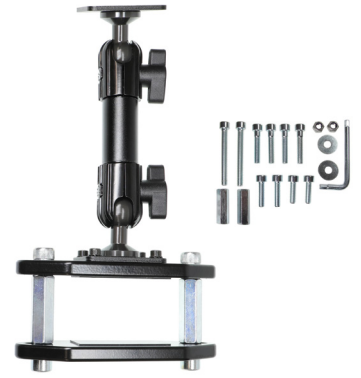

Item no. 215981

FORKLIFT CLAMP MOUNT WITH STANDARD DUTY PEDESTAL MOUNT ARM

Item no.	Product
215978	Length 140 mm, width between rods 72 mm
215979	Length 172 mm, width between rods 72 mm
215980	Length 140 mm, width between rods 97 mm
215981	Length 172 mm, width between rods 97 mm

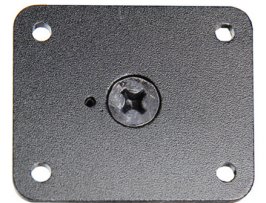



VIBRATION DAMPERS

- Reduces vibrations and bumps, for use in a rough environment
- Mount the vibration dampers between the holder and the Pedestal Mount
- Damper builds 17 mm, damper plate builds 22 mm
- AMPS holes

REDUCES VIBRATIONS & BUMPS!



Item no. 215881

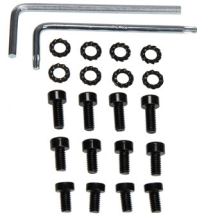

Item no. 215998

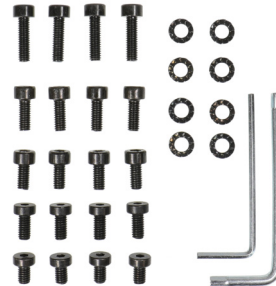

Item no. 215882



Item no. 215997



<i>Item no.</i>	<i>Product</i>	<i>Max weight</i>
215881	Vibration damper, hard (2 pcs)	For installations weighing up to 1500g
215882	Vibration damper, soft (2 pcs)	For installations weighing up to 300g
215998	Vibration damper plate 68x68 mm, hard	For installations weighing up to 1500g
215997	Vibration damper plate 68x68 mm, soft	For installations weighing up to 300g



2-PART MOUNTING SOLUTIONS

- Super strong Pedestal Mounts for a very stable installation of heavier devices
- AMPS holes for easy attachment of printer holder onto Pedestal Mount
- Provides improved working environment with printer within easy reach
- For use in any vehicle, flat surface, round pole or pipe, square rod
- Custom design holders and mounting adapters with a perfect fit
- For convenience and functionality in professional everyday use
- Contact Brodit for customized solutions on special projects
- Strong products with low weight, withstand a lot of weight
- Easy insert/removal or with quick release MultiMoveClip
- Printer holders made of high grade ABS/Acetal plastic
- Pedestal Mounts made of aluminum
- Durable products with robust design
- Discreet design, color: black
- Made in Sweden



PRINTER HOLDERS

CUSTOMIZED HOLDERS & ADAPTERS
FOR EVERYDAY PROFESSIONAL USE



PEDESTAL MOUNTS

SUPER STRONG MOUNTING PLATFORMS
FOR INSTALLATION OF HEAVIER DEVICES



Mounting Solutions for Devices on Boats

Firm installations

- Two part Mounting Solution you can install yourself
- Convenient to use, easy to adjust, discreet design
- Keeps your device within easy sight and reach
- Weather resistant materials with low weight
- Safer navigation, better reception
- Firm installations on flat surfaces, poles and pipes
- Predrilled holes, easy installation
- No vibration noise from the products
- A variety of mount locations and holder features
- Easy insert/removal of the device in the holder
- Made in Sweden

Attach anywhere

- Flat surfaces
- Round poles and pipes
- Square rods

Take it with you

- Move the Holder easily for use both outside/inside on the boat
- Can also be used in the car or other vehicles, as well as in the office/home

For more info please visit www.brodit.com

Weather resistant Holders and Mounting Platforms
for installation of mobile devices on boats



1 Two part Mounting Solution

Customized device Holders

- Customized device Holders with a perfect fit
- With/without charging or lock
- For device with/without case/jacket
- Made of ABS/Acetal plastic



Adjustable device Holders

- Adjustable Holders, fit many devices
- For device with/without case/jacket
- With/without charging
- Made of ABS/Acetal plastic



2

Pedestal Mounts

- A super strong modular system for a stable installation of heavier devices
- For any flat surfaces, poles, pipes
- Durable, weather resistant, low weight
- Hollow or solid range
- Made of aluminum



3

Your Solution!

- Every user has his/her unique requirements. From idea to design and manufacturing; Brodit offers a complete concept with customized quality products.
- Safe. Efficient. Convenient.



Reduces vibrations

- Heavy Duty Tough Sleeves: Robust case/ jacket with built in bumpers which reduces vibrations/bumps
- Charging via Sliding Power Block
- With or without lock
- Easy insert/removal thanks to quick connector
- Durable charging connector for frequent wear in everyday professional use
- Move easily between vehicle-vehicle-office

For rough environments

- Strong Mounting Platforms for installation of heavier devices in professional everyday use
- Robust Holders and Heavy Duty Tough Sleeves
- For all vehicles, flat surfaces, poles and pipes
- Durable products for use in rough environments
- Reduces vibrations and bumps
- Complete sets, or mix and match your own solution
- Improved working environment
- Safer driving and better mobile reception
- Within easy sight and reach, discreet design
- Customized products with a perfect fit
- Made in Sweden



Heavy-Duty Mounting Solutions

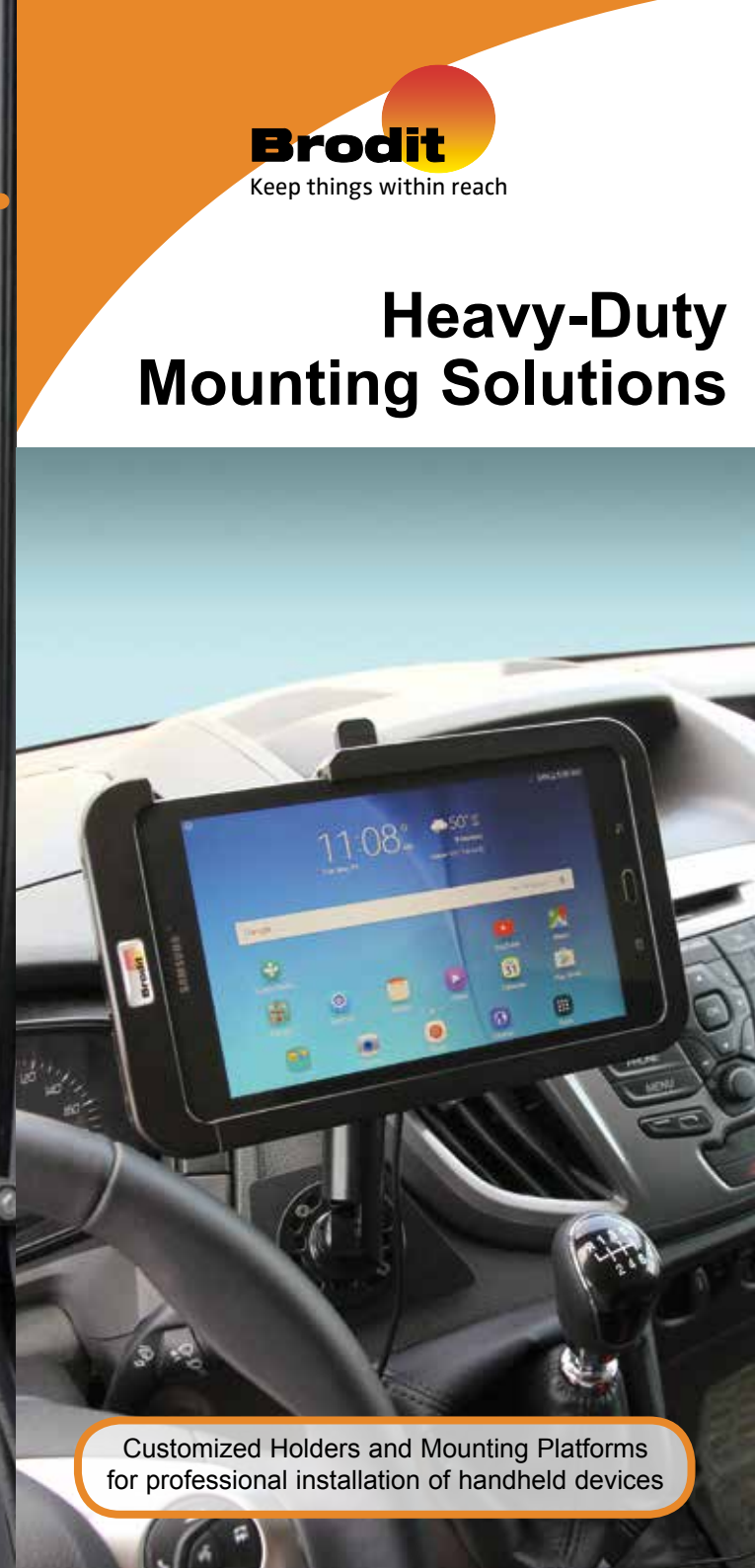

For more info please visit www.brodit.com

237012.705 ©2017 Brodit AB

Customized Holders and Mounting Platforms for professional installation of handheld devices

For any use...

- Cars, taxi-vehicles and busses
- Trucks, distribution vehicles
- Forklifts and warehouses
- Emergency vehicles
- Construction machines
- Agriculture, forestry
- Shops, exhibitions
- Factories, offices
- Aircrafts, boats

...for any device

- Rugged PDAs
- Tablets and monitors
- Bar code scanners
- Printers
- Payment terminals
- Alco locks
- Smartphones
- GPS devices
- Two-way radios

Two part Mounting Solution

1

Device Holders



- Customized Holders with a perfect fit
- With or without charging or lock
- Sleeves reduce vibrations/bumps
- Made of ABS/Acetal plastic
- Attach onto a Pedestal Mount/ProClip

2

Mounting Platforms

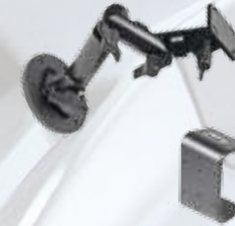

- Pedestal Mounts: Super strong modular system for installation of heavier devices. Made of aluminum. Use on all flat surfaces, poles or pipes.
- ProClip: Customized vehicle mounting bracket. Made of ABS/Acetal plastic. Firm fit.
- Predrilled holes for easy attachment of a device Holder

3

Your Solution!



- Strong and firm installation
- Within easy sight and reach
- Every user has his/her unique requirements. From idea to design and manufacturing; Brodit offers a complete concept with customized quality products.
- Safe. Efficient. Convenient.





Strong installations

- Extra sturdy and secure mounting platform
- For installation of heavier devices
- Pedestal Mounts, solid and hollow range
- Device Holders and Heavy Duty Tough Sleeves
- For use in any vehicle, flat surface, pole or pipe
- Durable products that withstand a lot of weight
- Complete sets, or mix and match your own solution
- Made in Sweden

Attach anywhere

- Flat surfaces
- Round poles and pipes
- Square rods

For more info please visit www.brodit.com

Brodit
Keep things within reach

Super Strong Mounting Solutions



Super strong aluminum Pedestal Mounts
for a stable installation of heavier devices

For any use...

- Cars, taxi-vehicles, busses
- Trucks, distribution vehicles
- Forklifts, warehouses
- Emergency vehicles
- Construction machines
- Agriculture, forestry
- Shops, exhibitions
- Factories, offices
- Aircrafts, boats

...for any device

- Rugged PDAs
- Tablets and monitors
- Bar code scanners
- Printers
- Payment terminals
- Alco locks
- Smartphones
- GPS devices
- Two-way radios

Two part Mounting Solution

1



Device Holders

- Customized with a perfect fit
- With or without charging or lock
- Heavy Duty Tough Sleeves
- Reduces vibrations and bumps
- Made of ABS/Acetal plastic
- Attach onto a Pedestal Mount

2



Pedestal Mounts

- A modular system for a stable and strong installation of heavier devices
- Durable, low weight
- Made of aluminum
- Predrilled holes for easy attachment of a device Holder

3



Your Solution!

- Strong and firm installation
- Within easy sight and reach
- Every user has his/her unique requirements. From idea to design and manufacturing; Brodit offers a complete concept with customized quality products.
- Safe. Efficient. Convenient.



Vehicle Device Mounting Solutions

Customized solutions

- Two part Mounting Solution you can install yourself
- Keeps your device within easy sight and reach
- Provides a firm installation with a perfect fit
- Convenient to use and easy to adjust
- Neat and discreet design that blends in well
- Safer driving and better reception
- A variety of Mount locations and Holder features
- Available for all vehicle makes and device brands
- Made of black high grade ABS/Acetal plastic
- Made in Sweden

Tablet on headrest

- Two part Mounting Solution
- Headrest Mounts for all standard seats
- Customized tablet Holders, with/without charging or lock

For more info please visit www.brodit.com

239332 705 ©2017 Brodit AB

Customized Holders and Mounting Platforms for installation of handheld devices in vehicles

For any device...

- Smartphones
- GPS devices
- Two-way radios
- Rugged PDAs
- Tablets
- Bar code scanners
- Printers
- Payment terminals
- Alco locks

...in any vehicle



Two part Mounting Solution

1



Device Holders

- Customized device Holders with a perfect fit
- With or without charging
- With tilt swivel, easy to adjust
- Attach onto a ProClip

2



Vehicle Mounts

- The ProClip is a vehicle specific mounting bracket with a very sturdy fit
- Snaps into place in gaps in the dashboard
- Pre-drilled holes for easy attachment of a Holder

3



Your Solution!

- Within easy sight and reach
- Every user has his/her unique requirements. From idea to design and manufacturing; Brodit offers a complete concept with customized quality products.
- Safe. Efficient. Convenient.

